



AAAF5051-05

5.0 x 5.0 mm Full-Color Surface Mount LED Lamp

DESCRIPTIONS

- The Blue source color devices are made with InGaN on Sapphire-substrate Light Emitting Diode
- The Reddish-Orange source color devices are made with AlGaInP on Si-substrate Light Emitting Diode
- The Green source color devices are made with InGaN on Sapphire-substrate Light Emitting Diode
- Electrostatic discharge and power surge could damage the LEDs
- It is recommended to use a wrist band or anti-electrostatic glove when handling the LEDs
- All devices, equipments and machineries must be electrically grounded

FEATURES

- Suitable for all SMD assembly and solder process
- Available on tape and reel
- White SMD package, silicone resin
- Package: 500 pcs / reel
- Moisture sensitivity level: 3
- RoHS compliant

APPLICATIONS

- Backlight
- Status indicator
- Home and smart appliances
- Wearable and portable devices
- Healthcare applications

ATTENTION

Observe precautions for handling electrostatic discharge sensitive devices



PACKAGE DIMENSIONS

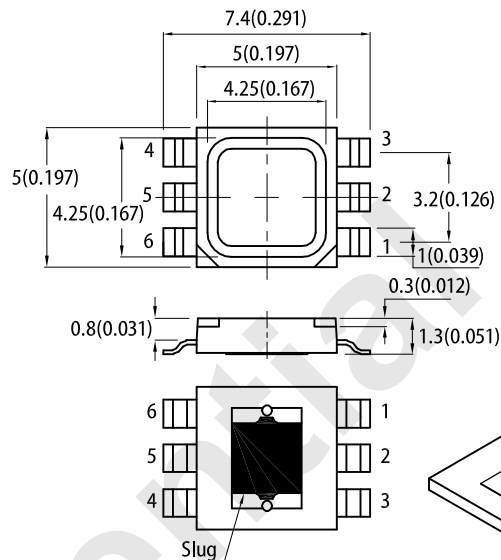

PRELIMINARY SPEC

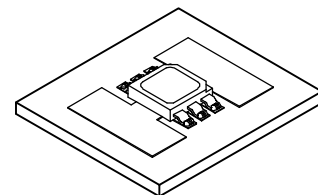
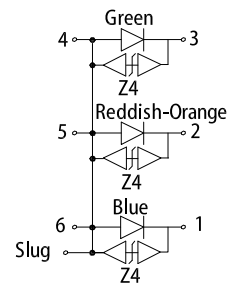

RECOMMENDED SOLDERING PATTERN

(units : mm; tolerance : ± 0.1)

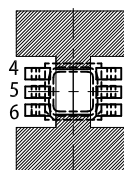
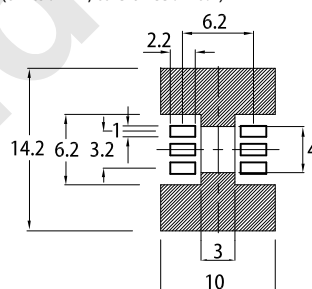

Solder mask

Notes:

1. All dimensions are in millimeters (inches).
2. Tolerance is ±0.15(0.006") unless otherwise noted.
3. The specifications, characteristics and technical data described in the datasheet are subject to change without prior notice.
4. The device has a single mounting surface. The device must be mounted according to the specifications.

SELECTION GUIDE

Part Number	Emitting Color (Material)	Lens Type	Iv (mcd) @ 150mA [2]		Φv (lm) @ 150mA* [2]		Viewing Angle [1]
			Min.	Typ.	Min.	Typ.	2θ1/2
AAAF5051-05	Blue(InGaN)	Water Clear	1600	2300	5*	7.2*	120°
	Reddish-Orange (AlGaInP)		1900	4000	8.6*	14*	
	Green(InGaN)		7000	9000	20*	28*	

Notes:

1. θ1/2 is the angle from optical centerline where the luminous intensity is 1/2 of the optical peak value.
2. Luminous intensity / luminous flux: +/-15%. *LEDs are binned according to their luminous flux.
3. Luminous intensity / luminous Flux value is traceable to CIE127-2007 standards..

ELECTRICAL / OPTICAL CHARACTERISTICS at T_A=25°C

Parameter	Symbol	Emitting Color	Value		Unit
			Typ.	Max.	
Wavelength at Peak Emission I _F = 150mA	λ_{peak}	Blue Reddish-Orange Green	452 633 515	-	nm
Dominant Wavelength I _F = 150mA	λ_{dom} ^[1]	Blue Reddish-Orange Green	460 624 525	-	nm
Spectral Bandwidth at 50% Φ REL MAX I _F = 150mA	$\Delta\lambda$	Blue Reddish-Orange Green	25 20 30	-	nm
Forward Voltage I _F = 150mA	V _F ^[2]	Blue Reddish-Orange Green	3.3 2.3 3.3	3.8 2.8 3.8	V
Allowable Reverse Current	I _R	Blue Reddish-Orange Green	-	85 85 85	mA
Temperature Coefficient of λ_{peak} I _F = 150mA, -10°C ≤ T ≤ 100°C	TC _{λ_{peak}}	Blue Reddish-Orange Green	0.04 0.13 0.05	-	nm/°C
Temperature Coefficient of λ_{dom} I _F = 150mA, -10°C ≤ T ≤ 100°C	TC _{λ_{dom}}	Blue Reddish-Orange Green	0.03 0.06 0.03	-	nm/°C
Temperature Coefficient of V _F I _F = 150mA, -10°C ≤ T ≤ 100°C	TC _V	Blue Reddish-Orange Green	-3.0 -2.0 -3.0	-	mV/°C

Notes:

1. The dominant wavelength (λ_d) above is the setup value of the sorting machine. (Tolerance λ_d : ±1nm.)
2. Forward voltage: ±0.1V.
3. Wavelength value is traceable to CIE127-2007 standards.
4. Excess driving current and / or operating temperature higher than recommended conditions may result in severe light degradation or premature failure.

ABSOLUTE MAXIMUM RATINGS at T_A=25°C

Parameter	Symbol	Value			Unit
		Blue	Reddish-Orange	Green	
Power Dissipation	P _D	0.57	0.42	0.57	W
Reverse Voltage	V _R	5	5	5	V
Junction Temperature	T _j	125	115	125	°C
Operating Temperature	T _{op}	-40 to +85			°C
Storage Temperature	T _{stg}	-40 to +85			°C
DC Forward Current	I _F ^[1]	150	150	150	mA
Peak Forward Current	I _{FM} ^[2]	300	300	300	mA
Electrostatic Discharge Threshold (HBM)	-	8000	8000	8000	V
Thermal Resistance (Junction / Ambient)	R _{th JA} ^[1]	80	100	120	°C/W
Thermal Resistance (Junction / Solder point)	R _{th JS} ^[1]	35	45	55	°C/W

Notes:

1. Results from mounting on Aluminum Board.
2. 1/10 Duty Cycle, 0.1ms Pulse Width.
3. Relative humidity levels maintained between 40% and 60% in production area are recommended to avoid the build-up of static electricity – Ref JEDEC/JESD625-A and JEDEC/J-STD-033.

TECHNICAL DATA

RELATIVE INTENSITY vs. WAVELENGTH

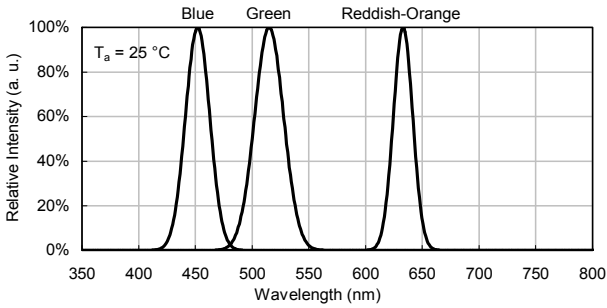

SPATIAL DISTRIBUTION

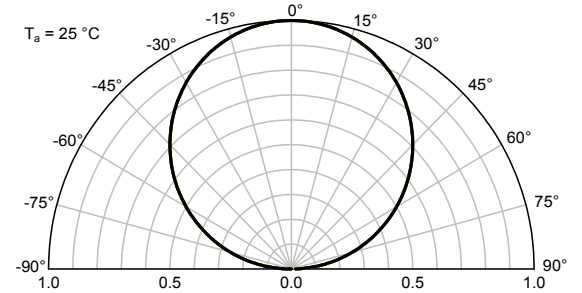

BLUE

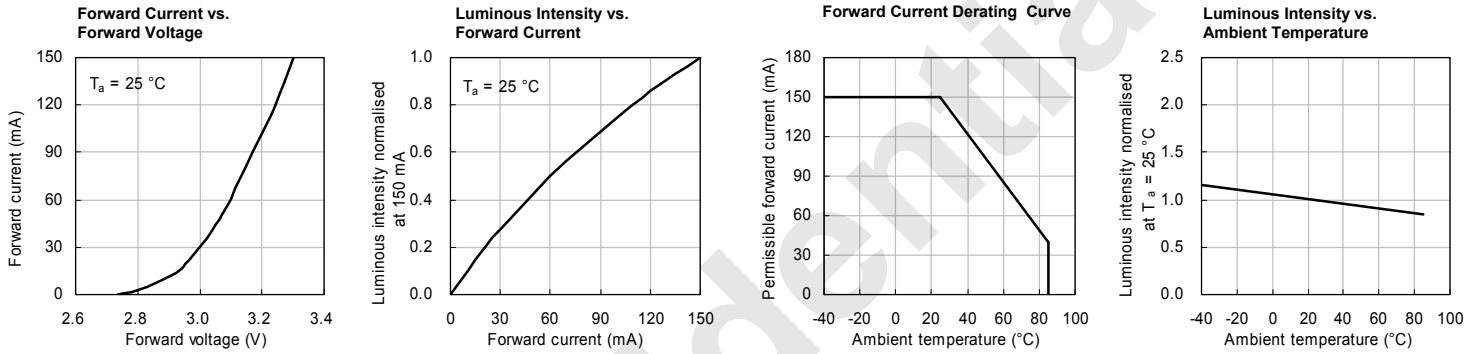

REDDISH-ORANGE

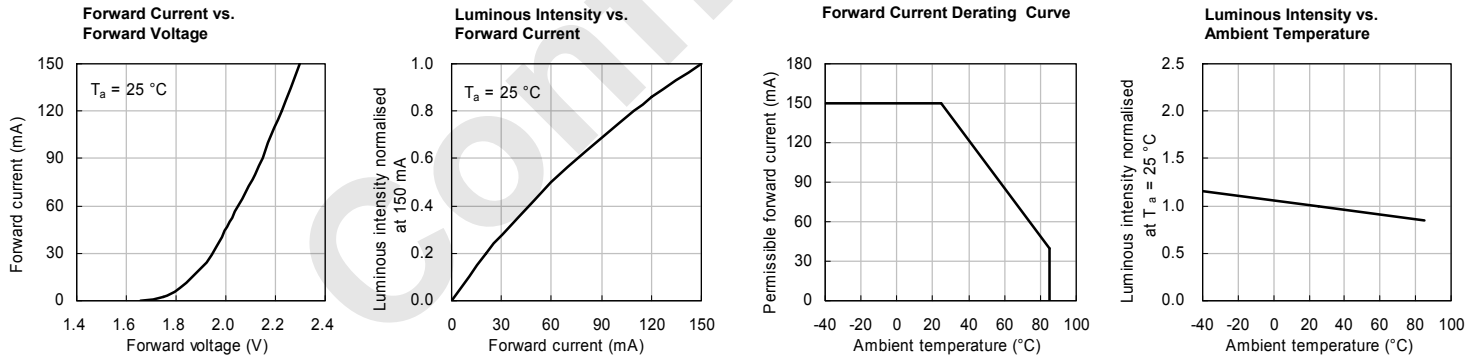

GREEN

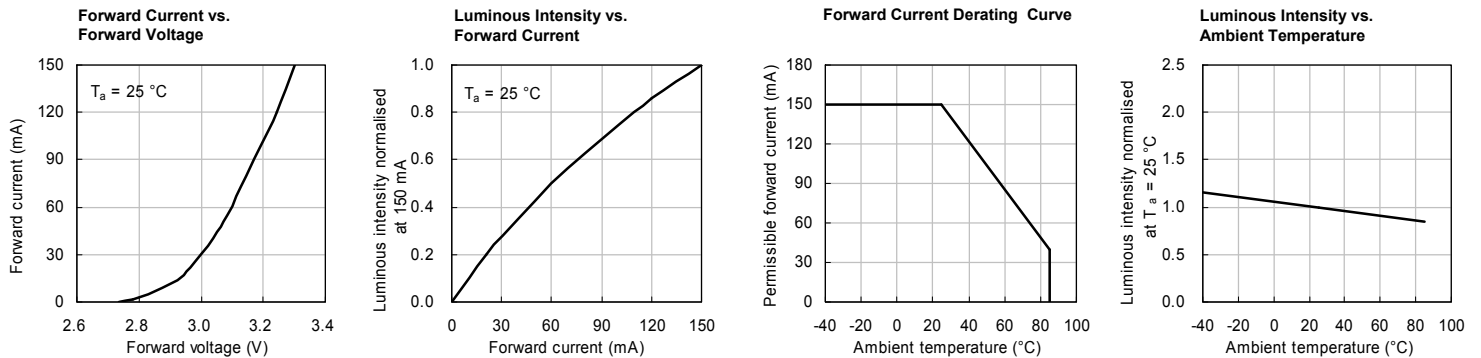

REFLOW SOLDERING PROFILE for LEAD-FREE SMD PROCESS

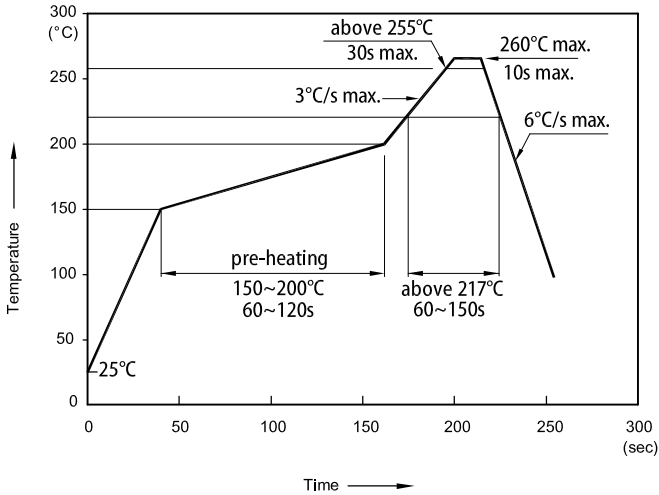

- Notes:
1. Don't cause stress to the LEDs while it is exposed to high temperature.
 2. The maximum number of reflow soldering passes is 2 times.
 3. Reflow soldering is recommended. Other soldering methods are not recommended as they might cause damage to the product.

TAPE SPECIFICATIONS (units : mm)

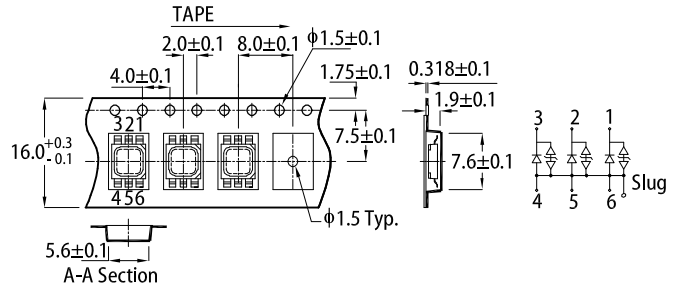

REEL DIMENSION (units : mm)

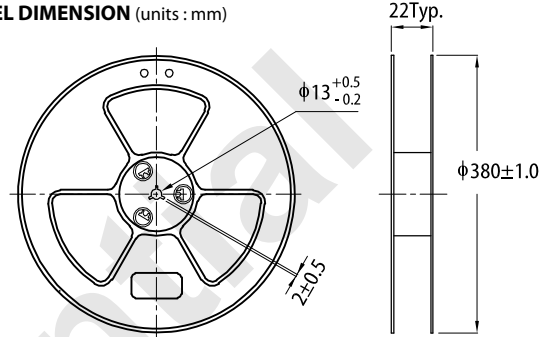

HANDLING PRECAUTIONS

Compare to epoxy encapsulant that is hard and brittle, silicone is softer and flexible. Although its characteristic significantly reduces thermal stress, it is more susceptible to damage by external mechanical force. As a result, special handling precautions need to be observed during assembly using silicone encapsulated LED products. Failure to comply might lead to damage and premature failure of the LED.

1. Handle the component along the side surfaces by using forceps or appropriate tools.
2. Do not directly touch or handle the silicone lens surface. It may damage the internal circuitry.
3. Do not stack together assembled PCBs containing exposed LEDs. Impact may scratch the silicone lens or damage the internal circuitry.

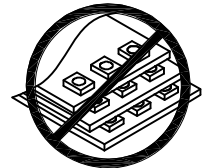
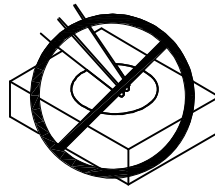
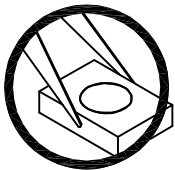

- 4-1. The inner diameter of the SMD pickup nozzle should not exceed the size of the LED to prevent air leaks.
- 4-2. A pliable material is suggested for the nozzle tip to avoid scratching or damaging the LED surface during pickup.
- 4-3. The dimensions of the component must be accurately programmed in the pick-and-place machine to insure precise pickup and avoid damage during production.
5. As silicone encapsulation is permeable to gases, some corrosive substances such as H₂S might corrode silver plating of leadframe. Special care should be taken if an LED with silicone encapsulation is to be used near such substances.

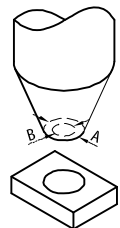

PACKING & LABEL SPECIFICATIONS

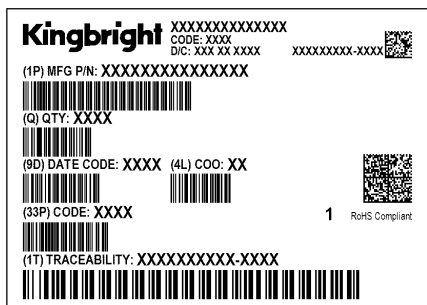
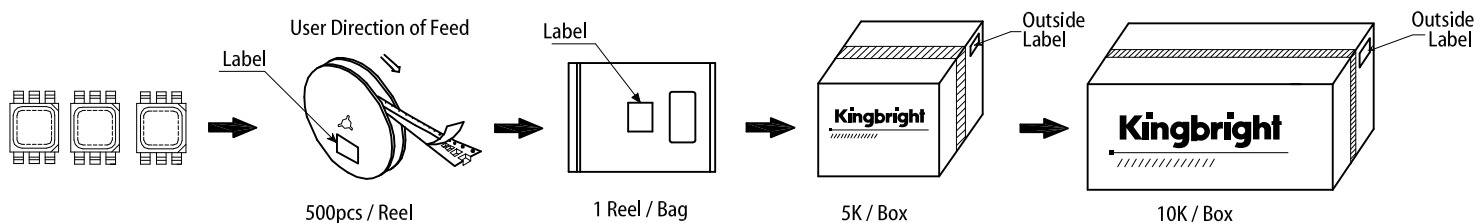

Confidential

PRECAUTIONARY NOTES

1. The information included in this document reflects representative usage scenarios and is intended for technical reference only.
2. The part number, type, and specifications mentioned in this document are subject to future change and improvement without notice. Before production usage customer should refer to the latest datasheet for the updated specifications.
3. When using the products referenced in this document, please make sure the product is being operated within the environmental and electrical limits specified in the datasheet. If customer usage exceeds the specified limits, Kingbright will not be responsible for any subsequent issues.
4. The information in this document applies to typical usage in consumer electronics applications. If customer's application has special reliability requirements or have life-threatening liabilities, such as automotive or medical usage, please consult with Kingbright representative for further assistance.
5. The contents and information of this document may not be reproduced or re-transmitted without permission by Kingbright.
6. All design applications should refer to Kingbright application notes available at <http://www.KingbrightUSA.com/ApplicationNotes>