

Part Number: AP1608YC

Yellow

### Features

- 1.6mmX0.8mm SMD LED, 1.1mm thickness.
- Low power consumption.
- Wide viewing angle.
- Ideal for backlight and indicator.
- Package: 2000pcs / reel.
- Moisture sensitivity level : level 3.
- RoHS compliant.

### Description

The Yellow source color devices are made with Gallium Arsenide Phosphide on Gallium Phosphide Yellow Light Emitting Diode.

### Package Dimensions

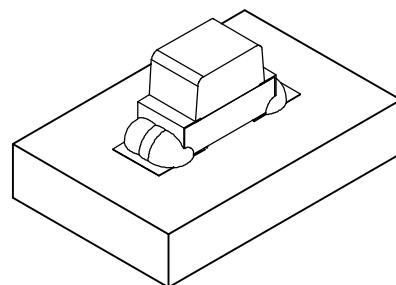
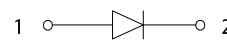
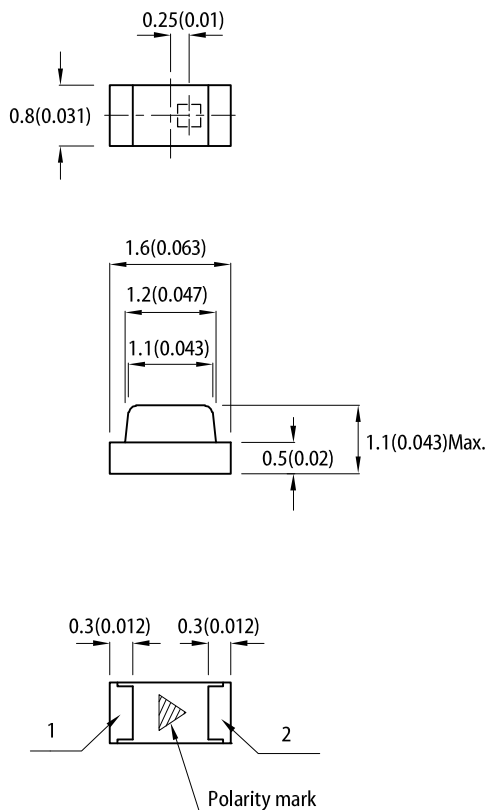

#### Notes:

1. All dimensions are in millimeters (inches).
2. Tolerance is  $\pm 0.1(0.004)$  unless otherwise noted.
3. The specifications, characteristics and technical data described in the datasheet are subject to change without prior notice.
4. The device has a single mounting surface. The device must be mounted according to the specifications.

## Selection Guide

Part No.	Emitting Color (Material)	Lens Type	Iv (mcd) [2] @ 20mA		Viewing Angle [1]
			Min.	Typ.	2θ1/2
AP1608YC	Yellow (GaAsP/GaP)	Water Clear	3	8	150°

Notes:

1. θ1/2 is the angle from optical centerline where the luminous intensity is 1/2 of the optical peak value.
2. Luminous intensity / luminous Flux: +/-15%.
3. Luminous intensity value is traceable to CIE127-2007 standards.

## Electrical / Optical Characteristics at TA=25°C

Symbol	Parameter	Emitting Color	Typ.	Max.	Units	Test Conditions
λpeak	Peak Wavelength	Yellow	590		nm	IF=20mA
λD [1]	Dominant Wavelength	Yellow	588		nm	IF=20mA
Δλ1/2	Spectral Line Half-width	Yellow	35		nm	IF=20mA
C	Capacitance	Yellow	20		pF	VF=0V;f=1MHz
VF [2]	Forward Voltage	Yellow	2.1	2.5	V	IF=20mA
IR	Reverse Current	Yellow		10	uA	VR=5V

Notes:

1. Wavelength: +/-1nm.
2. Forward Voltage: +/-0.1V.
3. Wavelength value is traceable to CIE127-2007 standards.
4. Excess driving current and / or operating temperature higher than recommended conditions may result in severe light degradation or premature failure.

## Absolute Maximum Ratings at TA=25°C

Parameter	Values	Units
Power dissipation	75	mW
DC Forward Current	30	mA
Peak Forward Current [1]	140	mA
Reverse Voltage	5	V
Operating Temperature	-40°C To +85°C	
Storage Temperature	-40°C To +85°C	

Notes:

1. 1/10 Duty Cycle, 0.1ms Pulse Width.
2. Relative humidity levels maintained between 40% and 60% in production area are recommended to avoid the build-up of static electricity – Ref JEDEC/JESD625-A and JEDEC/J-STD-033.

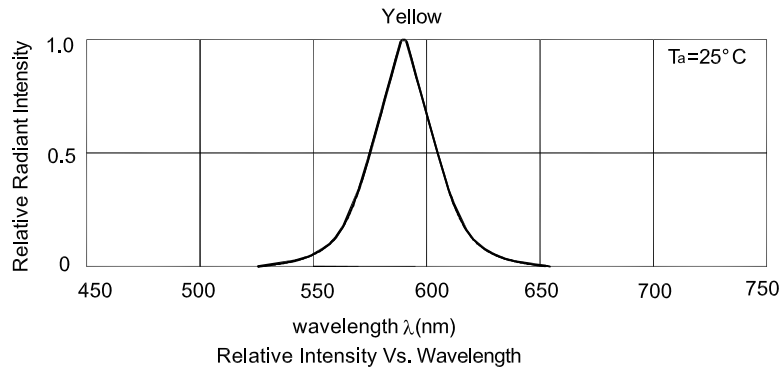

**Yellow**

**AP1608YC**

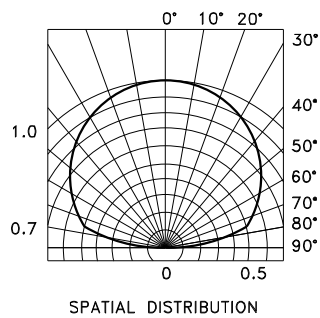
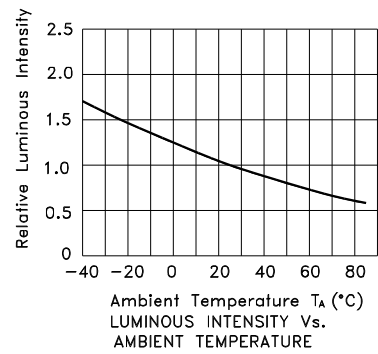
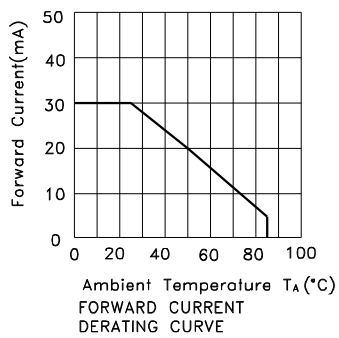
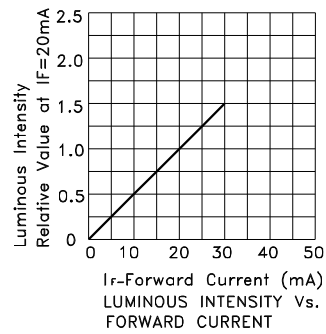
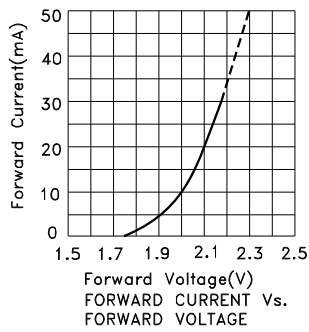

## AP1608YC

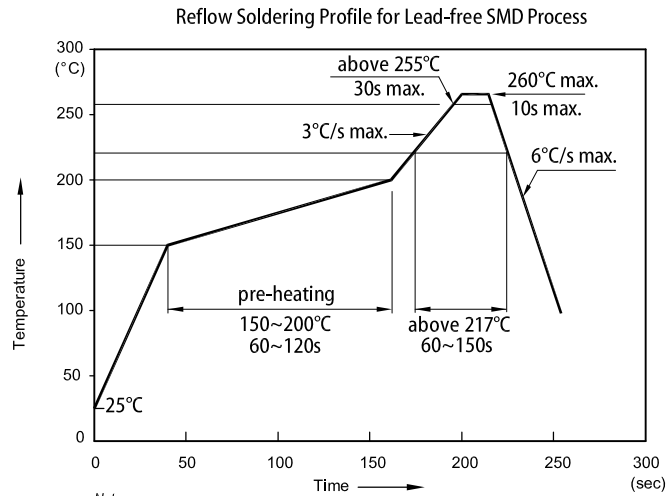

### Recommended Soldering Pattern (Units : mm; Tolerance: $\pm 0.1$ )

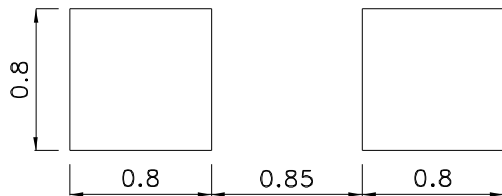

### Reel Dimension

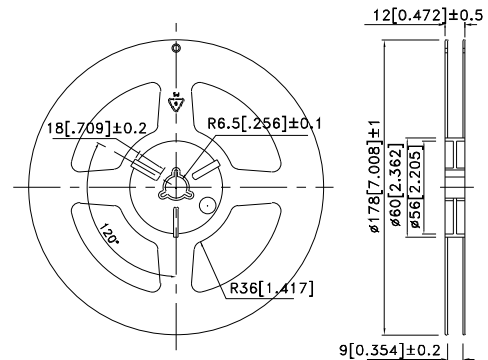

### Tape Dimensions (Units : mm)

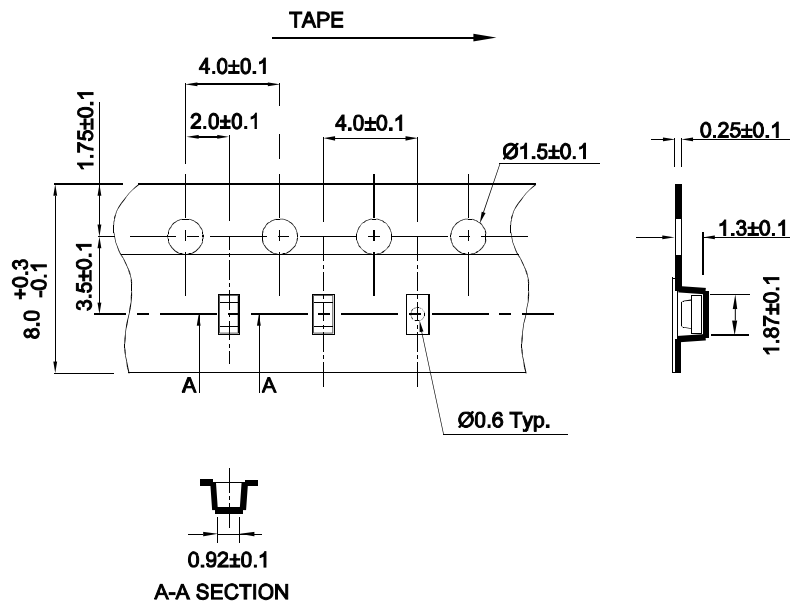

## PACKING & LABEL SPECIFICATIONS

## AP1608YC

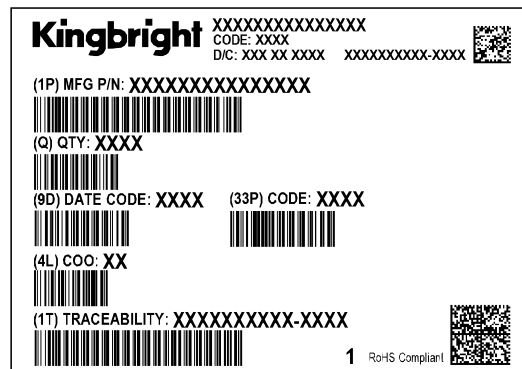
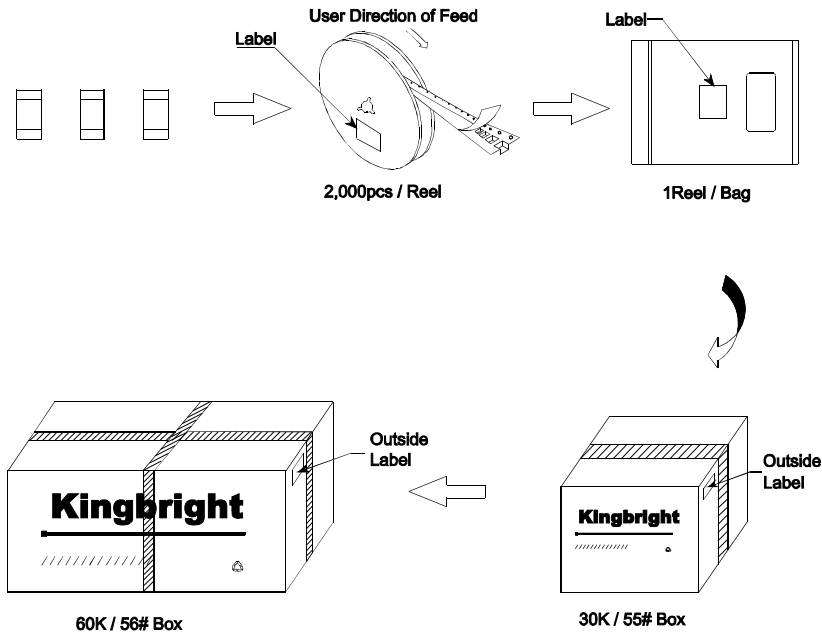

### Terms and conditions for the usage of this document

1. The information included in this document reflects representative usage scenarios and is intended for technical reference only.
2. The part number, type, and specifications mentioned in this document are subject to future change and improvement without notice. Before production usage customer should refer to the latest datasheet for the updated specifications.
3. When using the products referenced in this document, please make sure the product is being operated within the environmental and electrical limits specified in the datasheet. If customer usage exceeds the specified limits, Kingbright will not be responsible for any subsequent issues.
4. The information in this document applies to typical usage in consumer electronics applications. If customer's application has special reliability requirements or have life-threatening liabilities, such as automotive or medical usage, please consult with Kingbright representative for further assistance.
5. The contents and information of this document may not be reproduced or re-transmitted without permission by Kingbright.
6. All design applications should refer to Kingbright application notes available at <http://www.KingbrightUSA.com/ApplicationNotes>