

Part Number: APHB1608SGEC

Super Bright Green  
High Efficiency Red

### Features

- 1.6mmX0.8mm SMT LED, 0.5mm thickness.
- Compatible with reflow soldering.
- Available in various color combination.
- Package: 2000pcs / reel .
- Moisture sensitivity level : level 3.
- Tinned pads for improved solderability.
- RoHS compliant.

### Description

The Super Bright Green source color devices are made with Gallium Phosphide Green Light Emitting Diode.

The High Efficiency Red source color devices are made with Gallium Arsenide Phosphide on Gallium Phosphide Orange Light Emitting Diode.

### Package Dimensions

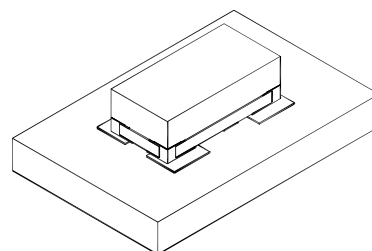
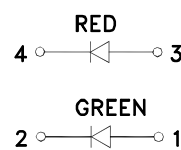
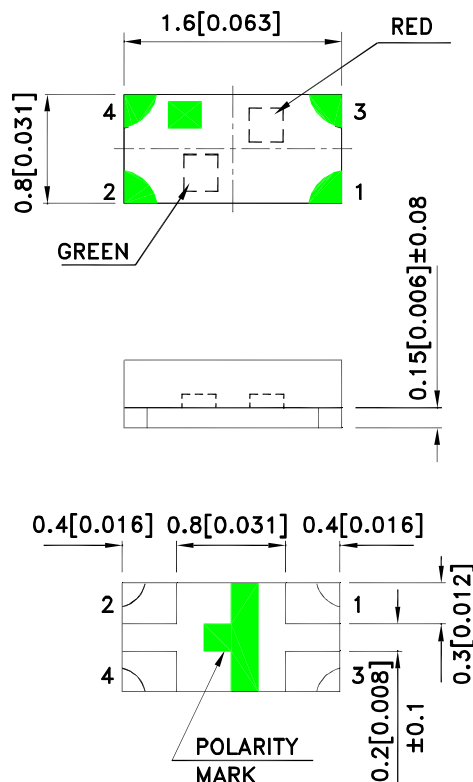

#### Notes:

1. All dimensions are in millimeters (inches).
2. Tolerance is ±0.15(0.006") unless otherwise noted.
3. The specifications, characteristics and technical data described in the datasheet are subject to change without prior notice.
4. The device has a single mounting surface. The device must be mounted according to the specifications.



## Selection Guide

Part No.	Dice	Lens Type	Iv (mcd) [2] @ 20mA		Viewing Angle [1]
			Min.	Typ.	2θ1/2
APHB1608SGEC	Super Bright Green (GaP)	Water Clear	5	15	130°
			*5	*15	
	High Efficiency Red (GaAsP/GaP)		7	15	
			*5	*12	

Notes:

1. θ1/2 is the angle from optical centerline where the luminous intensity is 1/2 of the optical peak value.
2. Luminous intensity/ luminous Flux: +/-15%.
- \*Luminous intensity value is traceable to the CIE127-2007 compliant national standards.

## Electrical / Optical Characteristics at TA=25°C

Symbol	Parameter	Device	Typ.	Max.	Units	Test Conditions
$\lambda_{peak}$	Peak Wavelength	Super Bright Green High Efficiency Red	565 627		nm	I <sub>F</sub> =20mA
$\lambda_D$ [1]	Dominant Wavelength	Super Bright Green High Efficiency Red	568 617		nm	I <sub>F</sub> =20mA
$\Delta\lambda_{1/2}$	Spectral Line Half-width	Super Bright Green High Efficiency Red	30 45		nm	I <sub>F</sub> =20mA
C	Capacitance	Super Bright Green High Efficiency Red	15 15		pF	V <sub>F</sub> =0V;f=1MHz
V <sub>F</sub> [2]	Forward Voltage	Super Bright Green High Efficiency Red	2.2 2	2.5 2.5	V	I <sub>F</sub> =20mA
I <sub>R</sub>	Reverse Current	Super Bright Green High Efficiency Red		10 10	uA	V <sub>R</sub> = 5V

Notes:

1. Wavelength: +/-1nm.
2. Forward Voltage: +/-0.1V.
3. Wavelength value is traceable to the CIE127-2007 compliant national standards.

## Absolute Maximum Ratings at TA=25°C

Parameter	Super Bright Green	High Efficiency Red	Units
Power dissipation	62.5	75	mW
DC Forward Current	25	30	mA
Peak Forward Current [1]	140	160	mA
Reverse Voltage	5		V
Operating Temperature	-40°C To +85°C		
Storage Temperature	-40°C To +85°C		

Note:

1. 1/10 Duty Cycle, 0.1ms Pulse Width.

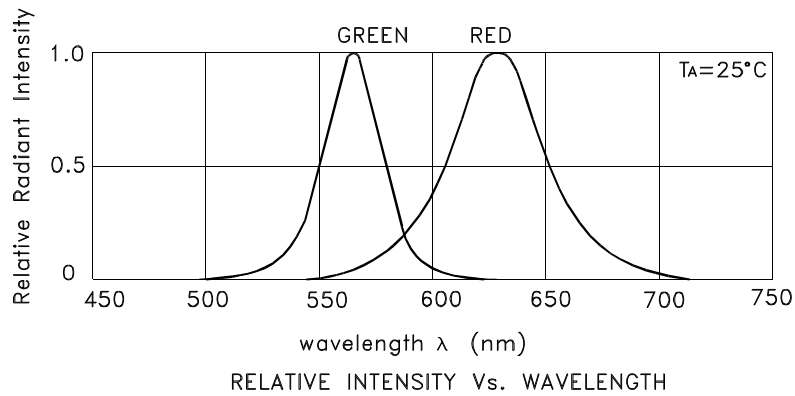

## APHB1608SGEC Super Bright Green

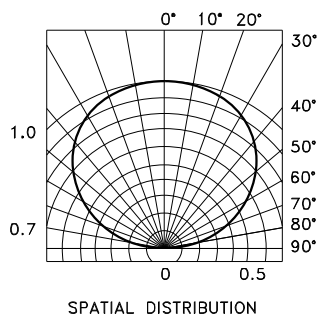
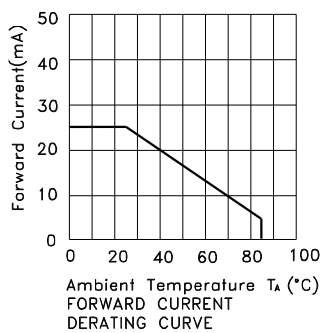
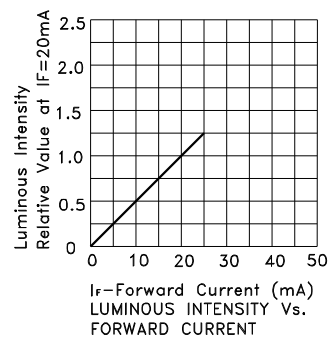
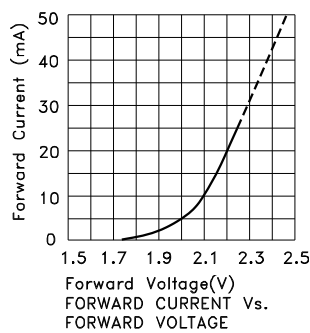

## High Efficiency Red

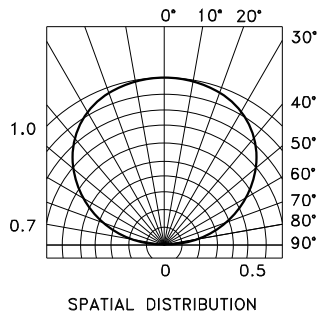
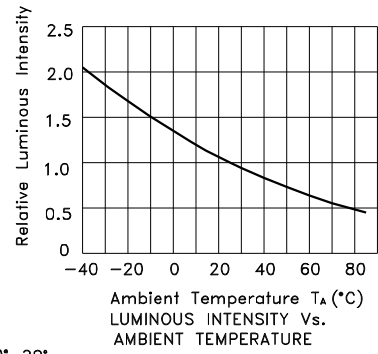
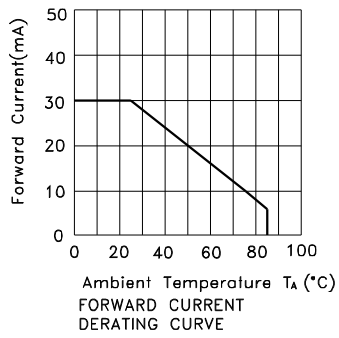
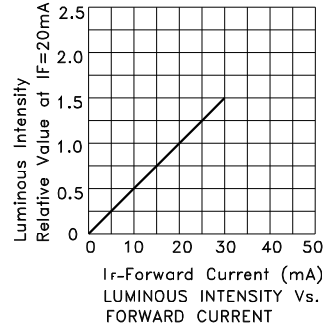
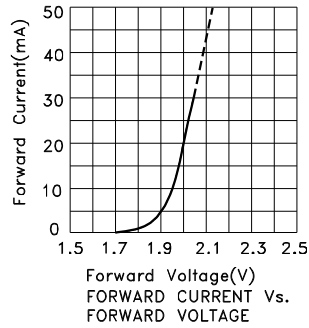

## APHB1608SGEC

Reflow soldering is recommended and the soldering profile is shown below.  
Other soldering methods are not recommended as they might cause damage to the product.

Reflow Soldering Profile For Lead-free SMT Process.



NOTES:

1. We recommend the reflow temperature 245°C(+/-5°C). The maximum soldering temperature should be limited to 260°C.
2. Don't cause stress to the epoxy resin while it is exposed to high temperature.
3. Number of reflow process shall be 2 times or less.

### Recommended Soldering Pattern (Units : mm; Tolerance: ± 0.1)



### Reel Dimension



### Tape Dimensions (Units : mm)

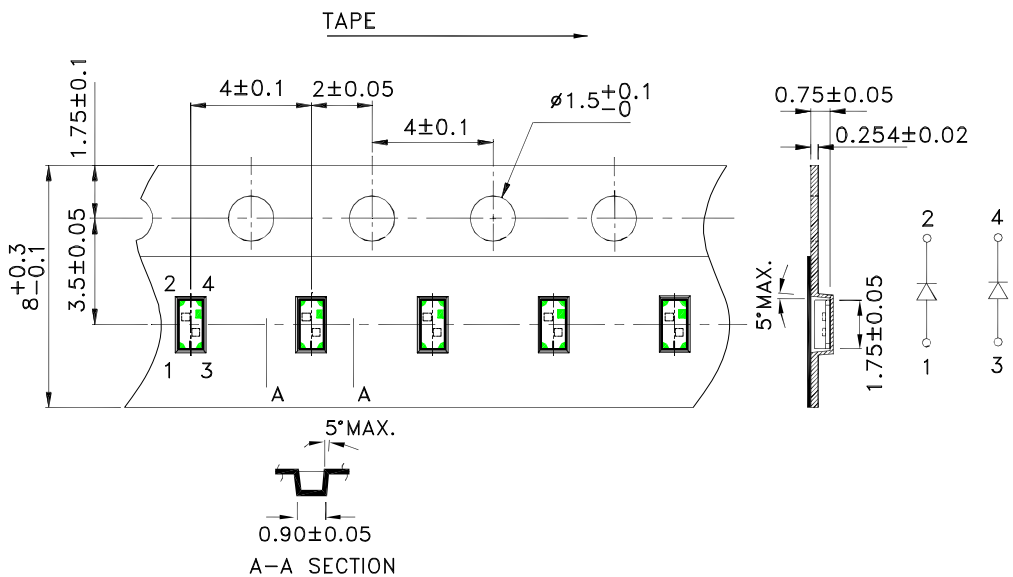

# Kingbright

## PACKING & LABEL SPECIFICATIONS

## APHB1608SGEC

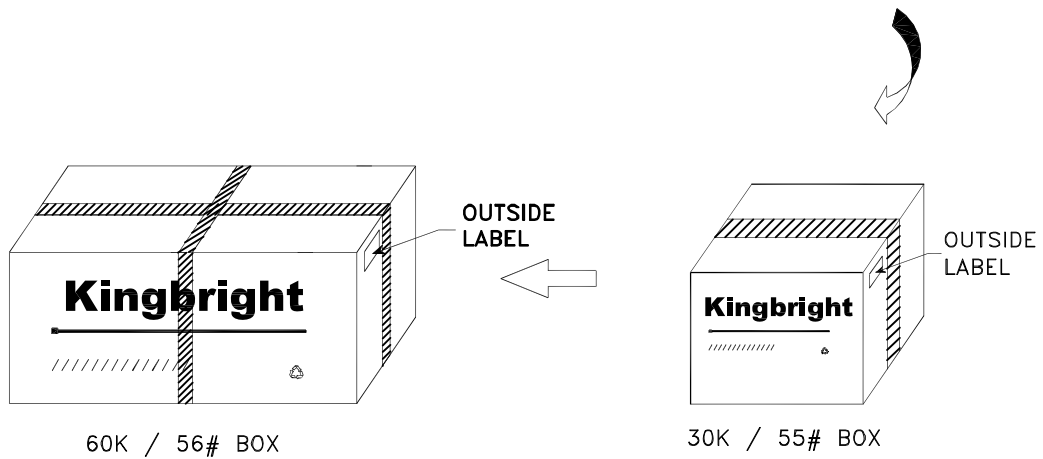
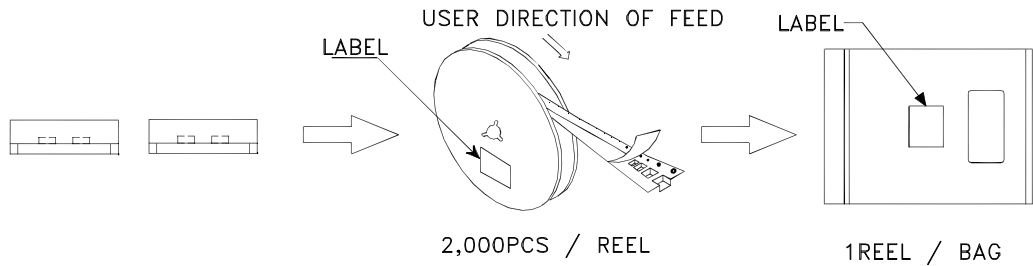

<h1>Kingbright</h1>					
P/NO: APHB1608xxx					
QTY: 2,000 pcs	Q.C.	<table border="1"> <tr> <td>Q C</td> </tr> <tr> <td>XX XX XXXX</td> </tr> <tr> <td>PASSED</td> </tr> </table>	Q C	XX XX XXXX	PASSED
Q C					
XX XX XXXX					
PASSED					
S/N: XXXX					
CODE: XXX					
LOT NO:					
xxxxxxxxxxxxxxxxxxxxxxxxxxxx					
RoHS Compliant					

All design applications should refer to Kingbright application notes available at <http://www.KingbrightUSA.com/ApplicationNotes>